

# Exploring Deep-Ocean Art

Research vessel *Falkor* is a scientific research vessel that supports innovative ocean research, technology, and education. You can follow the exciting new discoveries at <https://schmidtocean.org/>

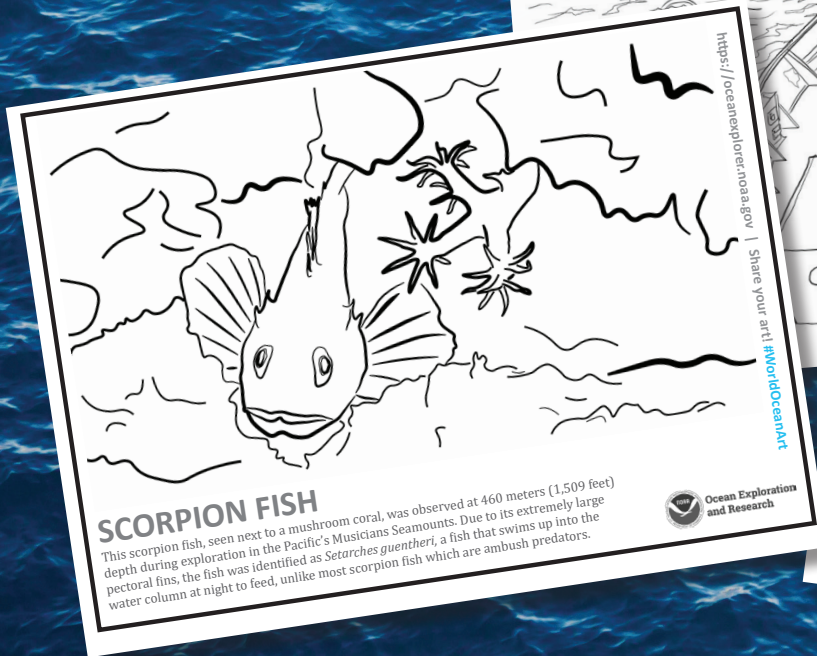
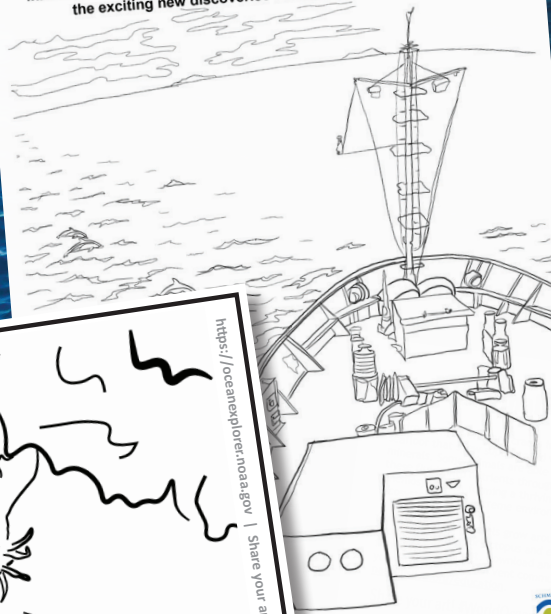

## SCORPION FISH

This scorpion fish, seen next to a mushroom coral, was observed at 460 meters (1,509 feet) depth during exploration in the Pacific's Musicians Seamounts. Due to its extremely large pectoral fins, the fish was identified as *Setarches guentheri*, a fish that swims up into the water column at night to feed, unlike most scorpion fish which are ambush predators.



<https://oceanexplorer.noaa.gov> | Share your art! #WorldOceanArt

## Community

full of  
ress

 NAUTILUSLIVE.ORG  
OCEAN EXPLORATION TRUST

Artist: Christina Machinski



## Happy World Oceans Month!



Ocean Exploration  
and Research



NAUTILUSLIVE.ORG  
OCEAN EXPLORATION TRUST



SCHMIDT  
OCEAN  
INSTITUTE

## Research Vessel

# Falkor

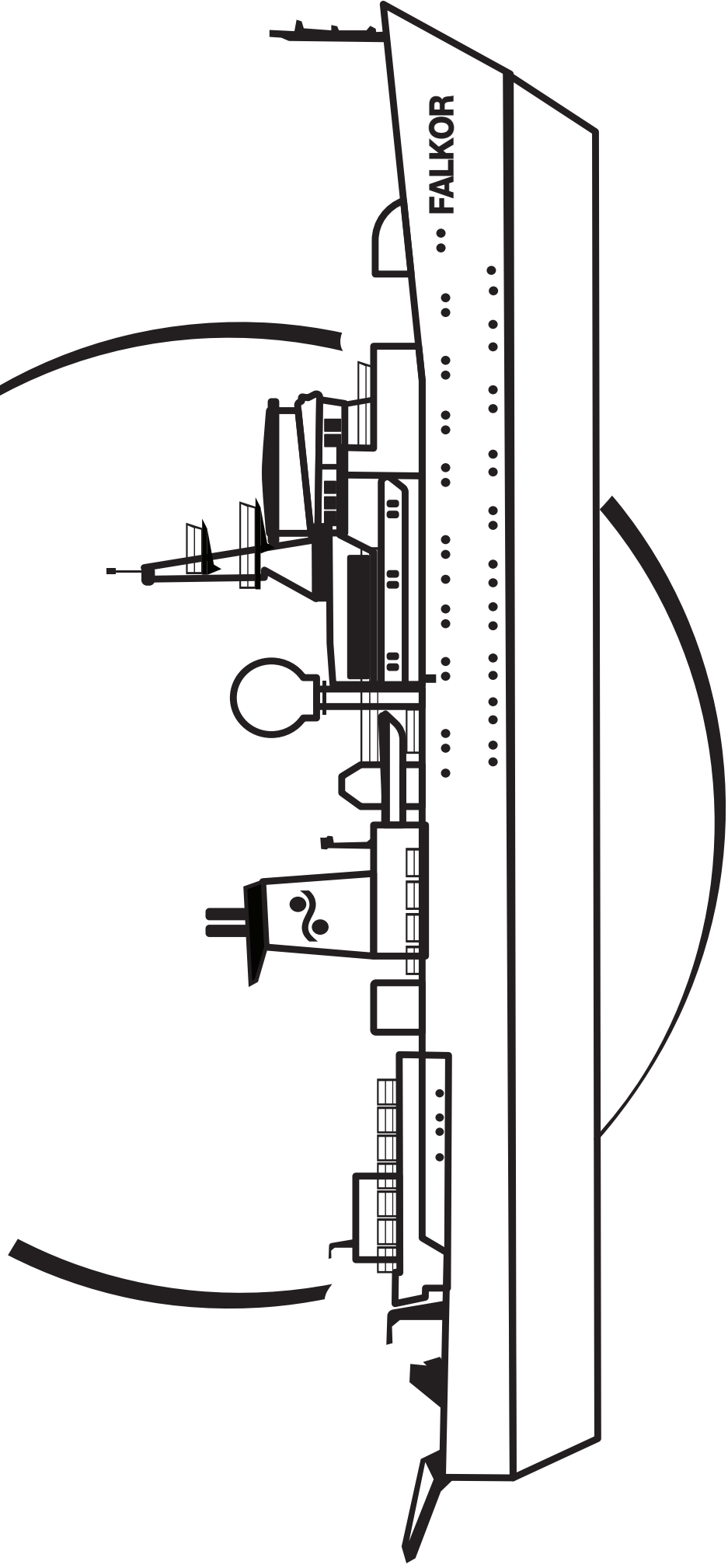

*Falkor* is a scientific research vessel that supports innovative ocean research, technology, and education. Scientists, artists, and students from around the world explore the ocean aboard *RV Falkor* and you can follow the exciting new discoveries at <https://schmidt-ocean.org/rv-falkor/status/>

**Remotely Operated Vehicle**

# SuBastian



ROV *SuBastian* is an underwater robot that can travel 4,500m below the surface to collect scientific data, video, and samples in the remote deep sea. You can learn more and dive deep with *SuBastian* at <https://schmidt-ocean.org>



Research vessel *Falkor* is a scientific research vessel that supports innovative ocean research, technology, and education. You can follow the exciting new discoveries at <https://schmidtocean.org/>

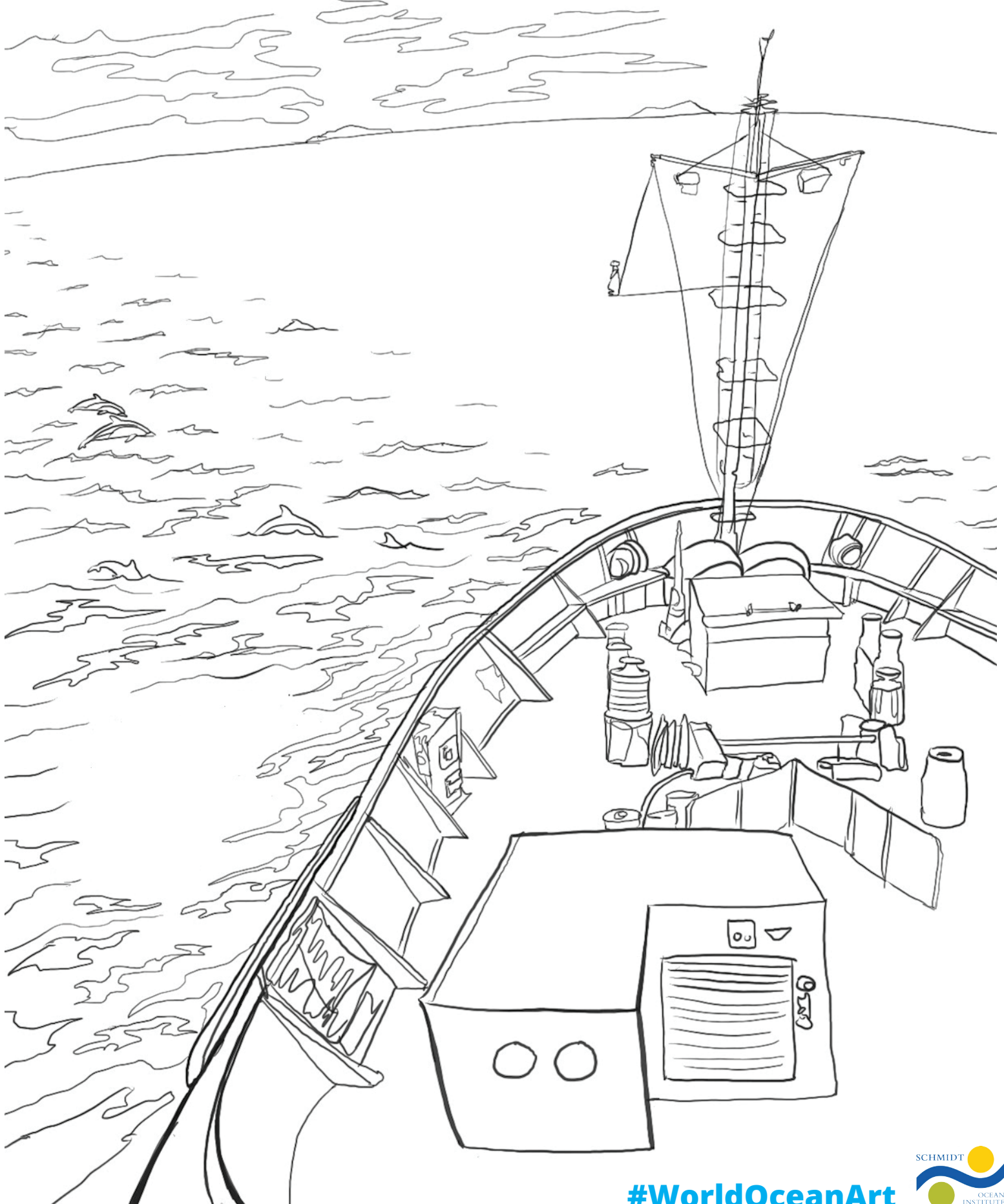



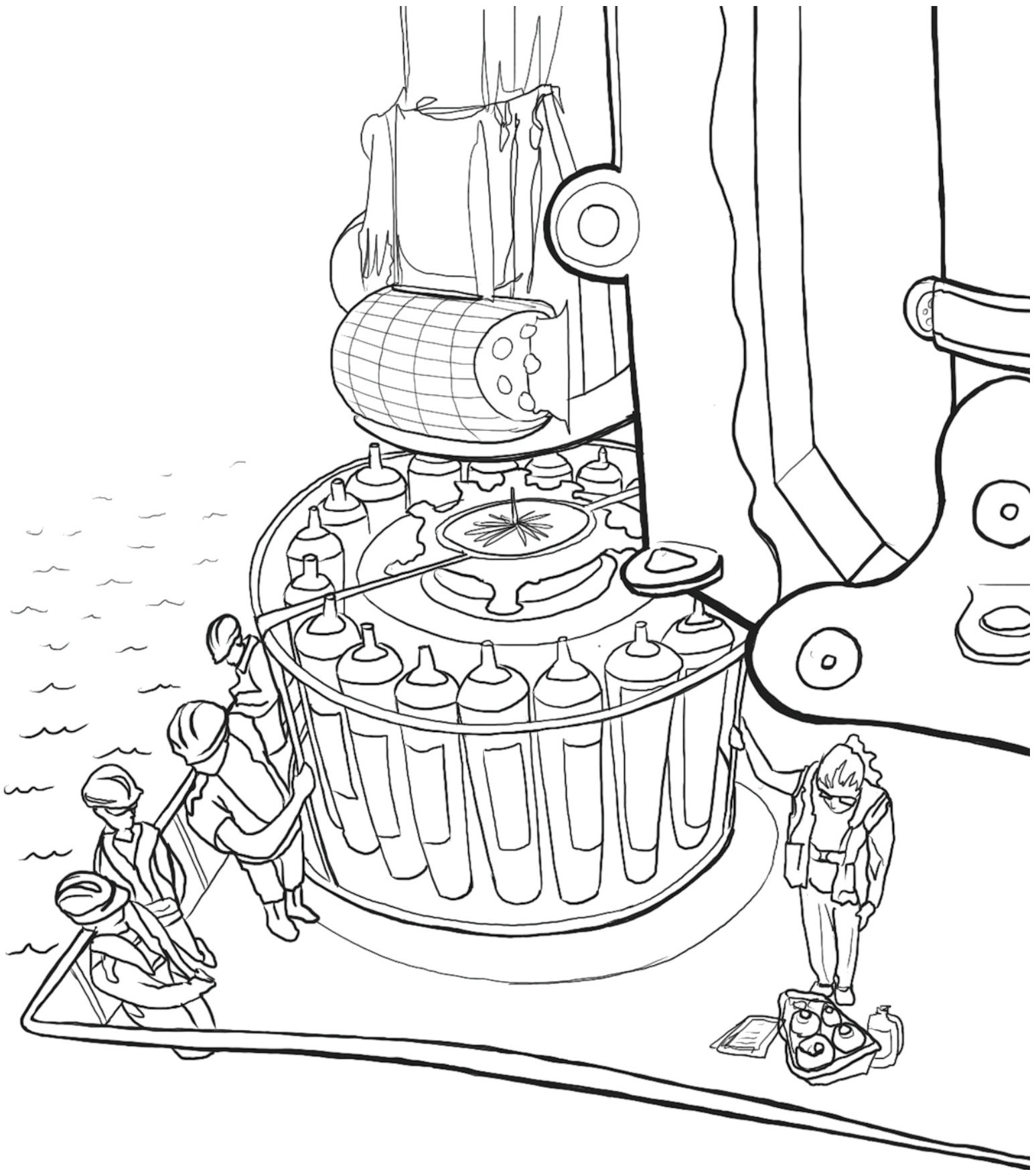

The *Falkor* crew and science team are deploying the CTD Rosette to determine physical, chemical, and biological properties of the water column. This information is used to characterize the water masses in the study region.

[#WorldOceanArt](#)

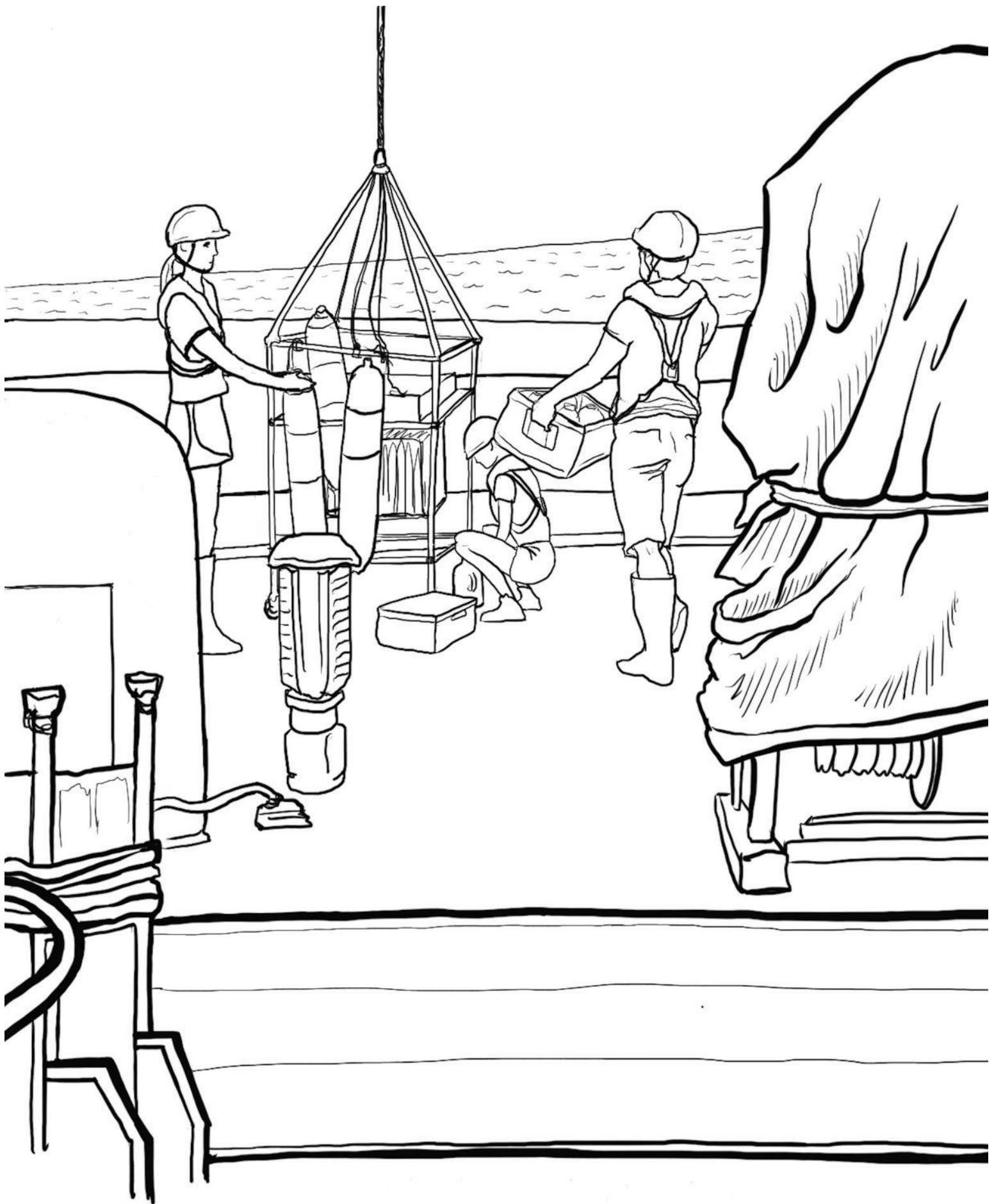

Scientists can bring different types of equipment onto R/V *Falkor* to study different aspects of the ocean. You can learn more about how we study the ocean here:

<https://schmidtocean.org/education/how-we-study-the-ocean/>

**#WorldOceanArt**



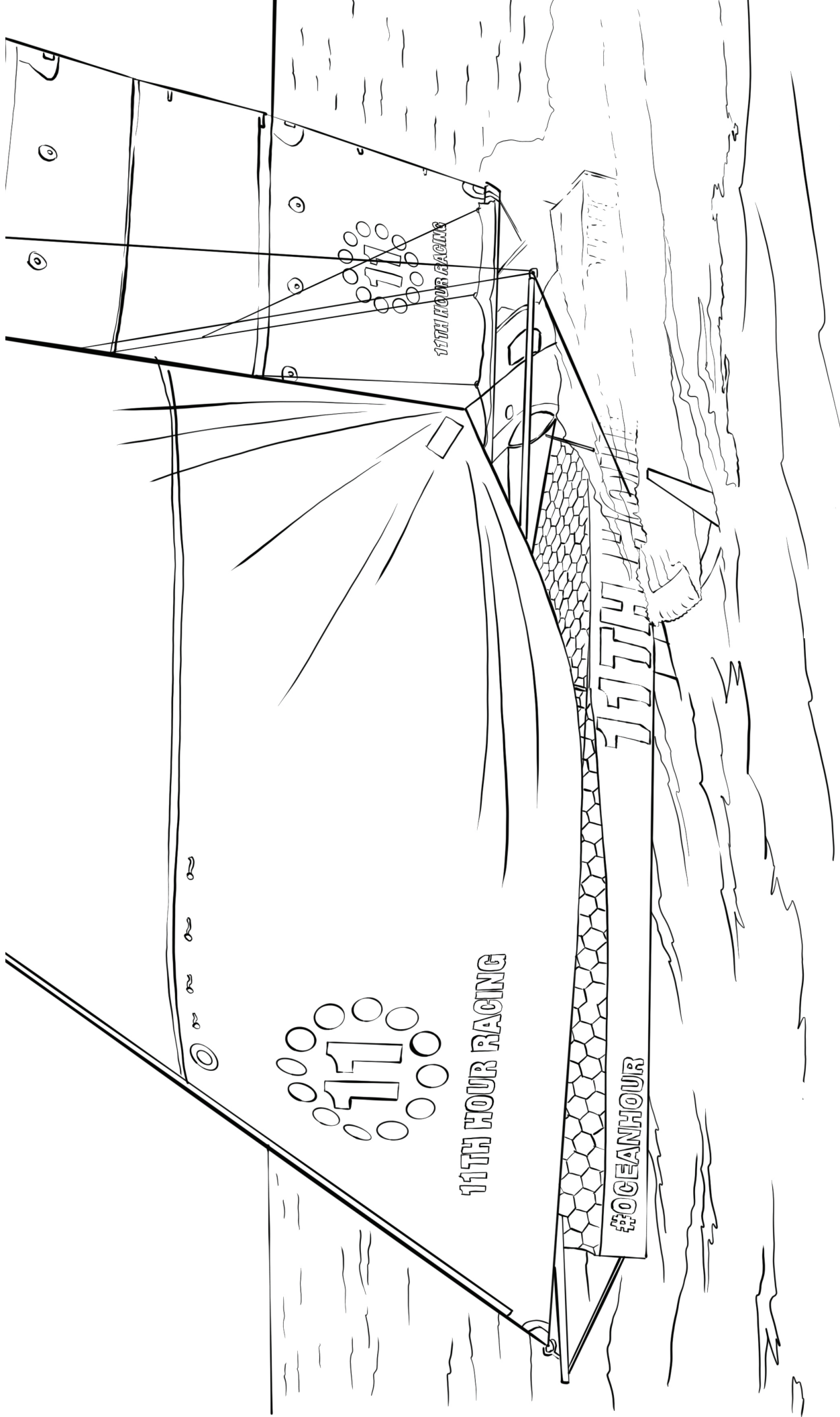

The 11th Hour Racing sailing team advocates for ocean health by working to create sustainable actions among sailing and coastal communities. The ocean connects us all from the surface to its depths.

**#OceanHour**  
@11THHOURTEAM

**#WorldOceanArt**



<https://oceanexplorer.noaa.gov> | Share your art! #WorldOceanArt

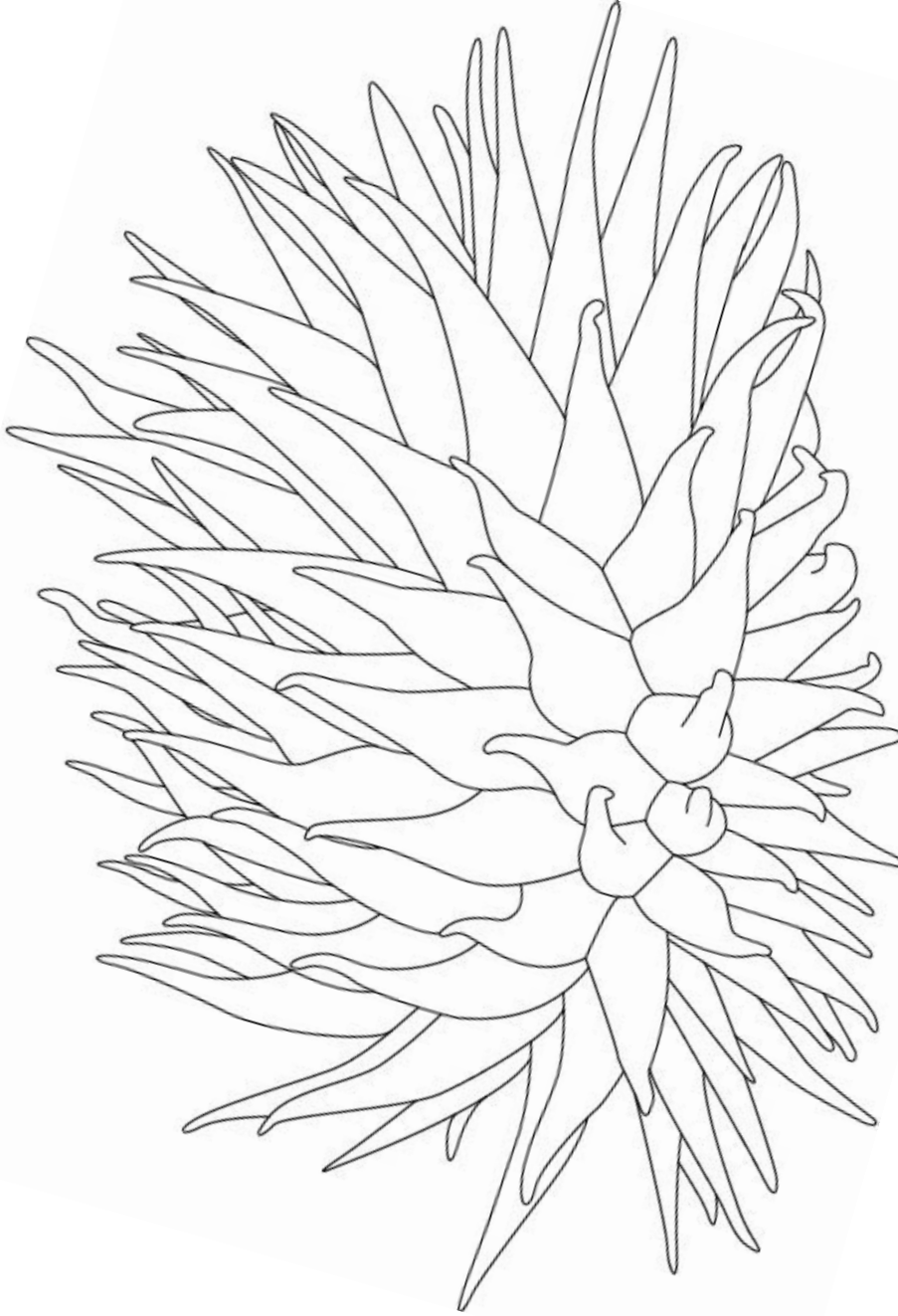

## SEA ANEMONE

Sea anemones get their common name from the flowering anemone plant found on land because, much like their namesake, many sea anemones come in bright, vibrant colors. However, unlike the flower, sea anemones are actually animals and are related to jellyfish and coral.



Ocean Exploration  
and Research

<https://oceanexplorer.noaa.gov> | Share your art! #WorldOceanArt

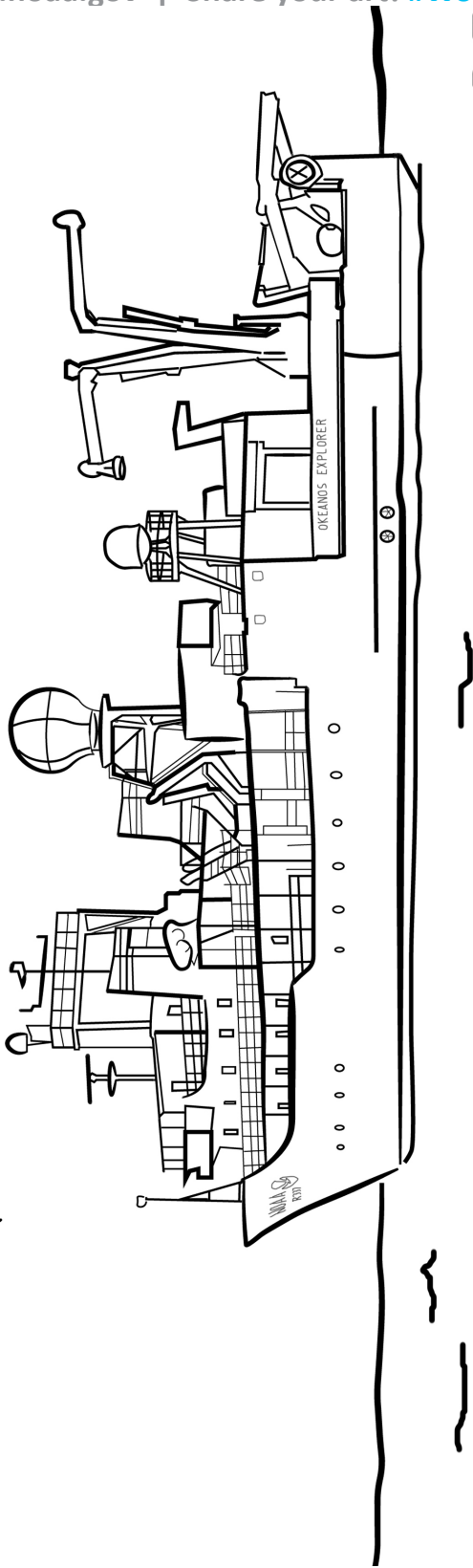
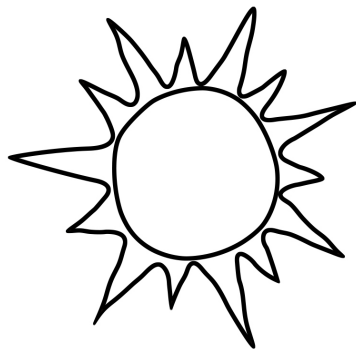

## NOAA SHIP OKEANOS EXPLORER

As the only U.S. federal vessel dedicated to exploring our largely unknown deep ocean, NOAA Ship *Okeanos Explorer* travels the globe—mapping, characterizing, advancing technology, and conducting education and outreach activities to increase our ability to understand, manage, and protect our ocean.



Ocean Exploration  
and Research

<https://oceanexplorer.noaa.gov> | Share your art! #WorldOceanArt



## GOLDEN CRAB

The golden crab (*Chaceon fenneri*) is a commercially important species found along the U.S. Atlantic coast and into the Gulf of Mexico. Golden crabs are most abundant among rock ledges, where they eat animals such as worms and mollusks.



Ocean Exploration  
and Research



<https://oceanexplorer.noaa.gov> | Share your art! #WorldOceanArt



## SCORPION FISH

This scorpion fish, seen next to a mushroom coral, was observed at 460 meters (1,509 feet) depth during exploration in the Pacific's Musicians Seamounts. Due to its extremely large pectoral fins, the fish was identified as *Setarches guentheri*, a fish that swims up into the water column at night to feed, unlike most scorpion fish which are ambush predators.



Ocean Exploration  
and Research

<https://oceanexplorer.noaa.gov> | Share your art! #WorldOceanArt

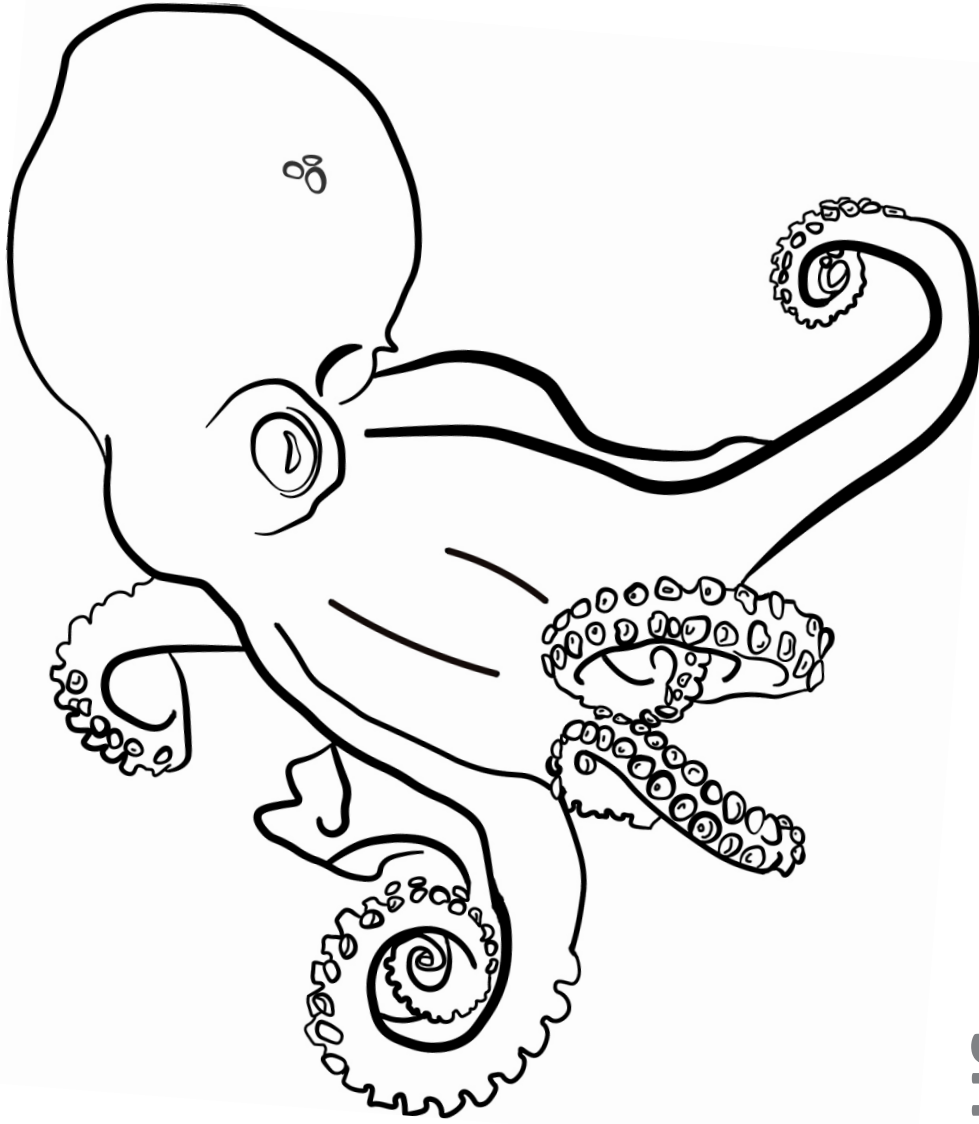

## OCTOPUS

Found in deep waters along the Atlantic coast, this species of octopus (*Muusoctopus johnsonianus*) is unique in having reverse countershading, light on top and dark on bottom, when compared to other octopods.



Ocean Exploration  
and Research

<https://oceanexplorer.noaa.gov> | Share your art! #WorldOceanArt

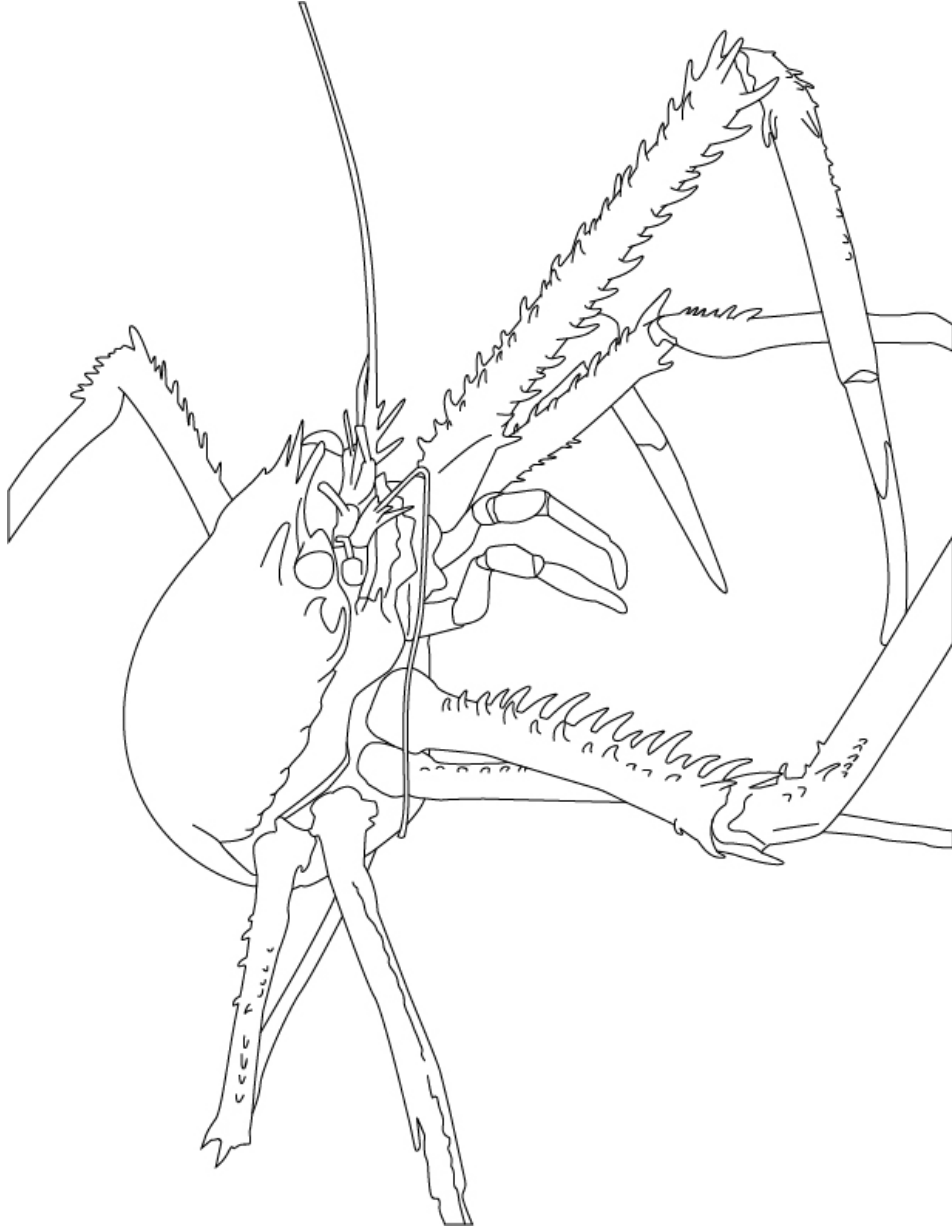

## SQUAT LOBSTER

Despite their common name and the fact that they do resemble lobsters, squat lobsters are actually more closely related to hermit crabs. The majority of squat lobsters are found in deeper waters where they move freely over bottom surfaces, often hiding beneath ledges or other bottom structures.



Ocean Exploration  
and Research



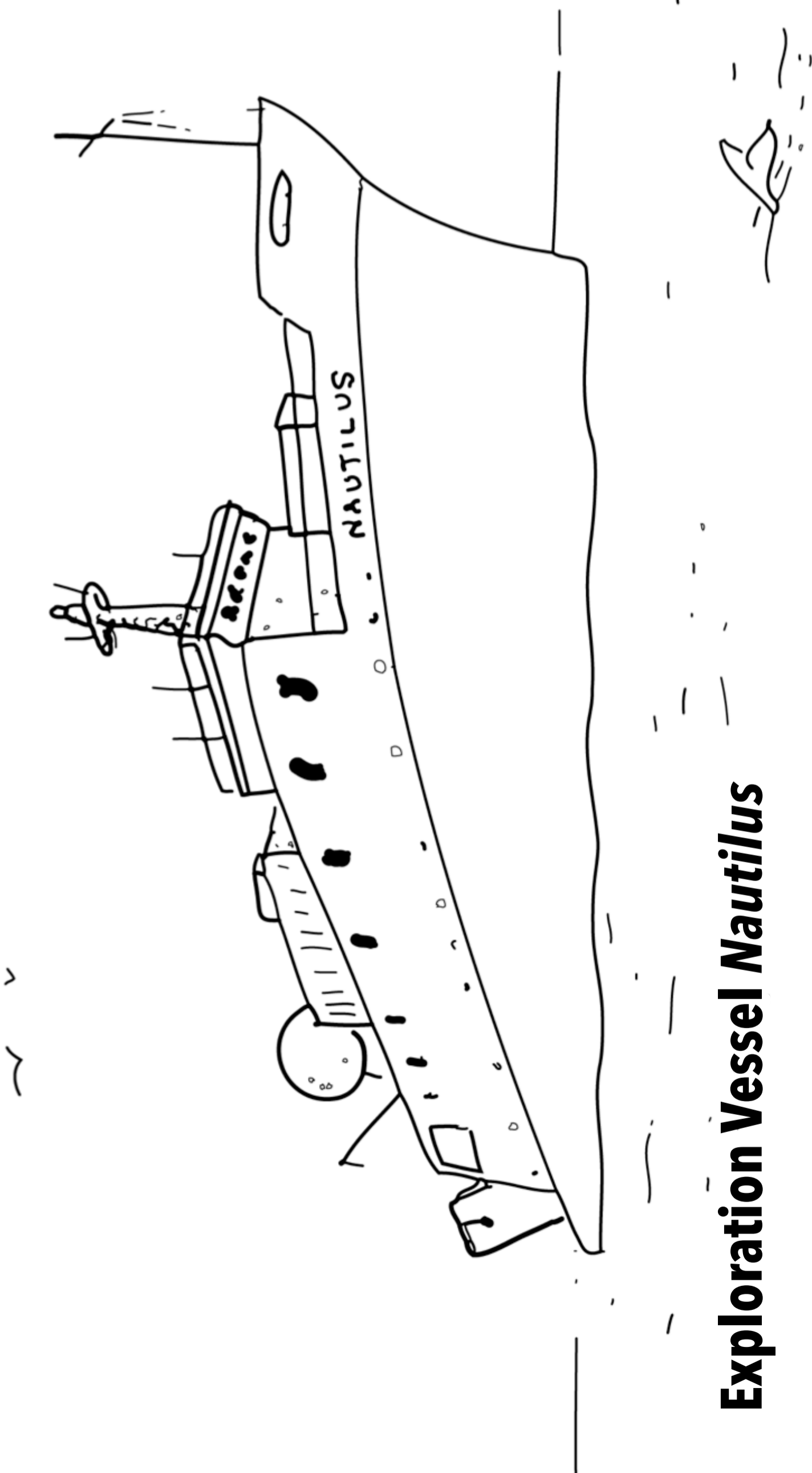

## Exploration Vessel *Nautilus*

E/V *Nautilus* is a 64-meter (211 foot) research vessel sailing with 31 science and engineering team members and 17 professional maritime crew. To explore the deep sea, the team on *Nautilus* will first create maps of the seafloor, then use remotely-operated vehicles to collect video footage and samples.

Learn more about our deep sea exploration at [nautiluslive.org/expeditions](https://nautiluslive.org/expeditions).

Share your art! #WorldOceanArt



NAUTILUSLIVE.ORG  
OCEAN EXPLORATION TRUST

Artist: Lindsay Holladay



# ROV HERCULES

ROV *Hercules* is a remotely-operated vehicle that helps us explore the seafloor – discovering new deep sea animals, sampling hydrothermal vent chimneys, and documenting ancient shipwrecks.

Cameras on *Hercules* stream live video to scientists, students, and the public watching NautilusLive.org across the world. Learn more about our exploration technology at [nautiluslive.org/science-tech](http://nautiluslive.org/science-tech).

Share your art! #WorldOceanArt



NAUTILUSLIVE.ORG  
OCEAN EXPLORATION TRUST

Artist: Karen Romano Young

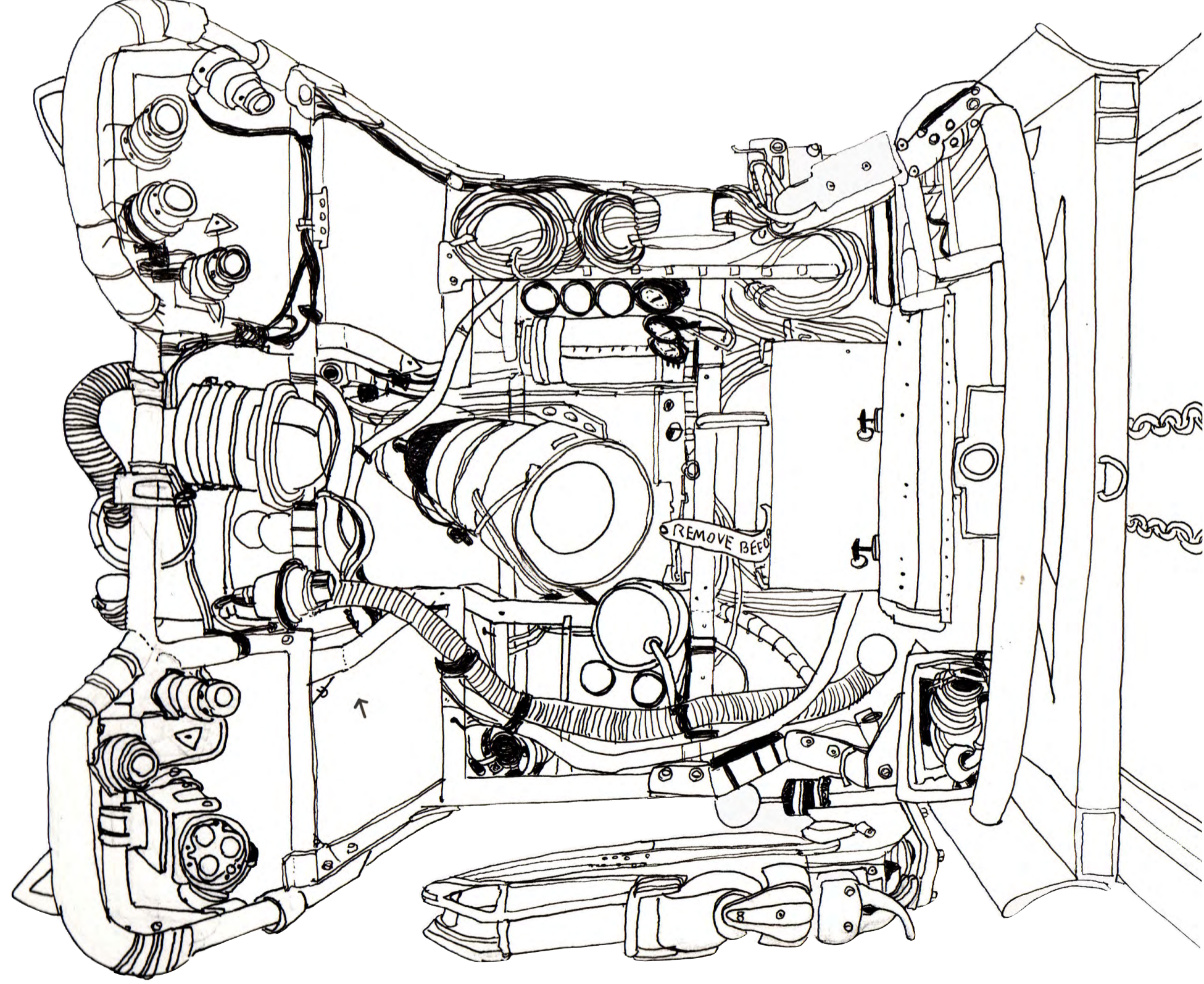



# Stubby Squid

*(Rossia pacifica)*

The stubby squid looks like a cross between an octopus and squid, but is more closely related to cuttlefish. This species spends life on the seafloor, activating a sticky mucus jacket and burrowing into the sediment to camouflage, leaving their eyes poking out to spot prey like shrimp and small fish.

Watch our original sighting of this googly-eyed squid and other favorite highlights at [nautiluslive.org/gallery](http://nautiluslive.org/gallery).

Share your art! #WorldOceanArt



Artist: Lindsay Holladay

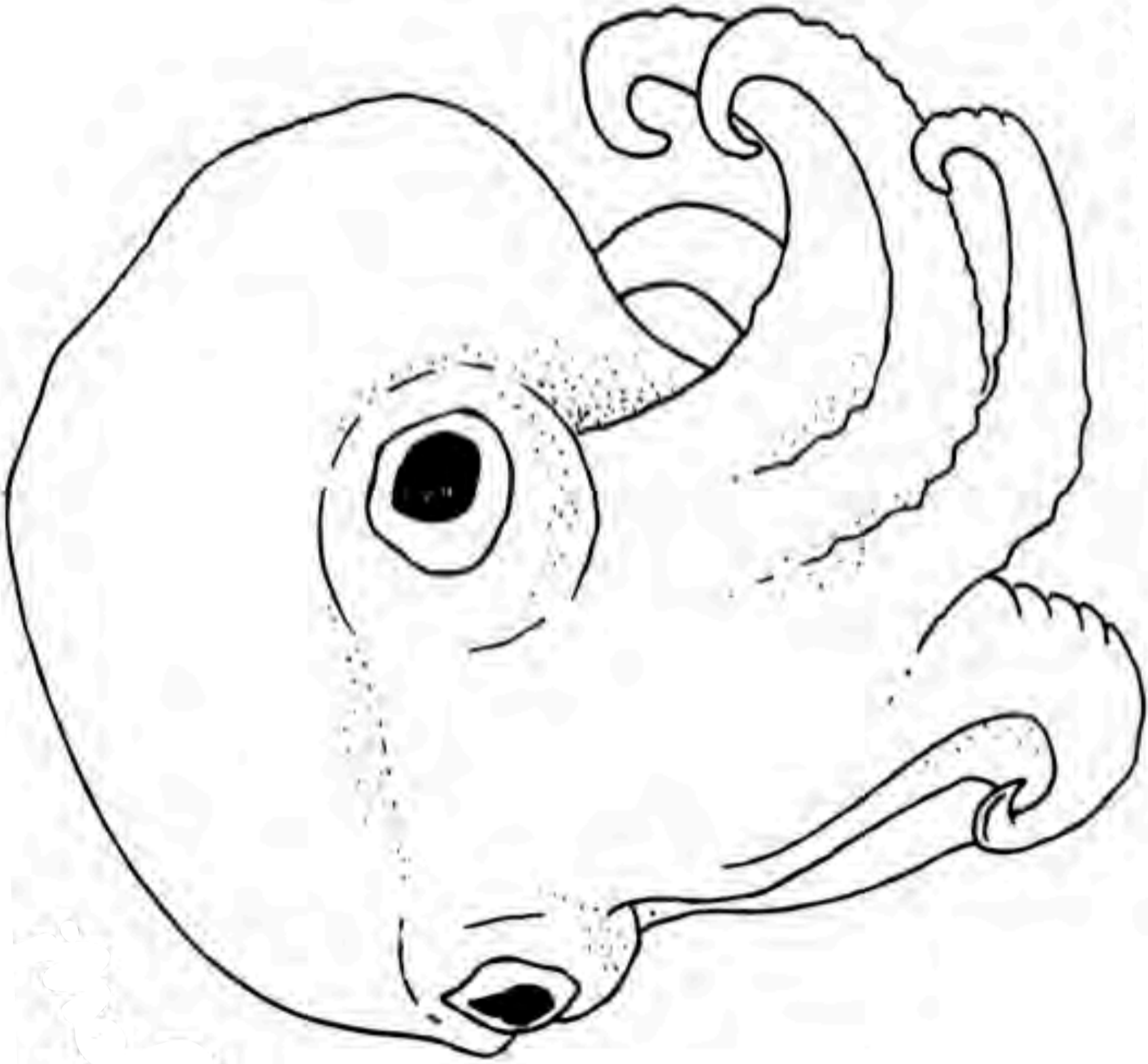

# Hydrothermal Vent Community

Hydrothermal vents are cracks in the seafloor that spew superheated water full of minerals. Some animals are able to process these fluids into nutrients through chemosynthesis, forming a thriving ecosystem in this extreme environment.

Tube worms and mussels grow around vents, providing habitat for octopus and eelpout fish to hide and hunt. Download and color your own hydrothermal vent community at [nautiluslive.org/education](http://nautiluslive.org/education).

Share your art! #WorldOceanArt

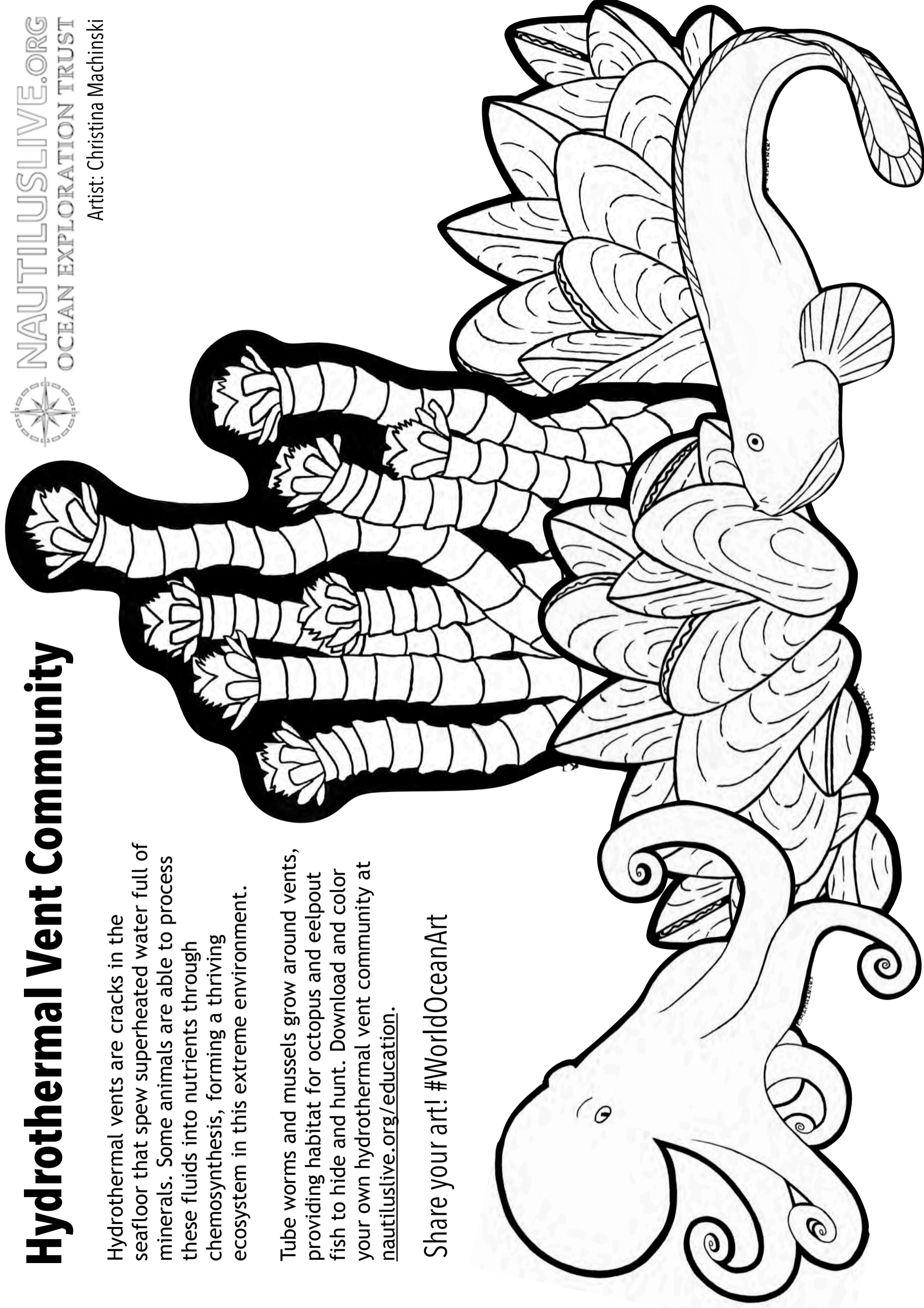



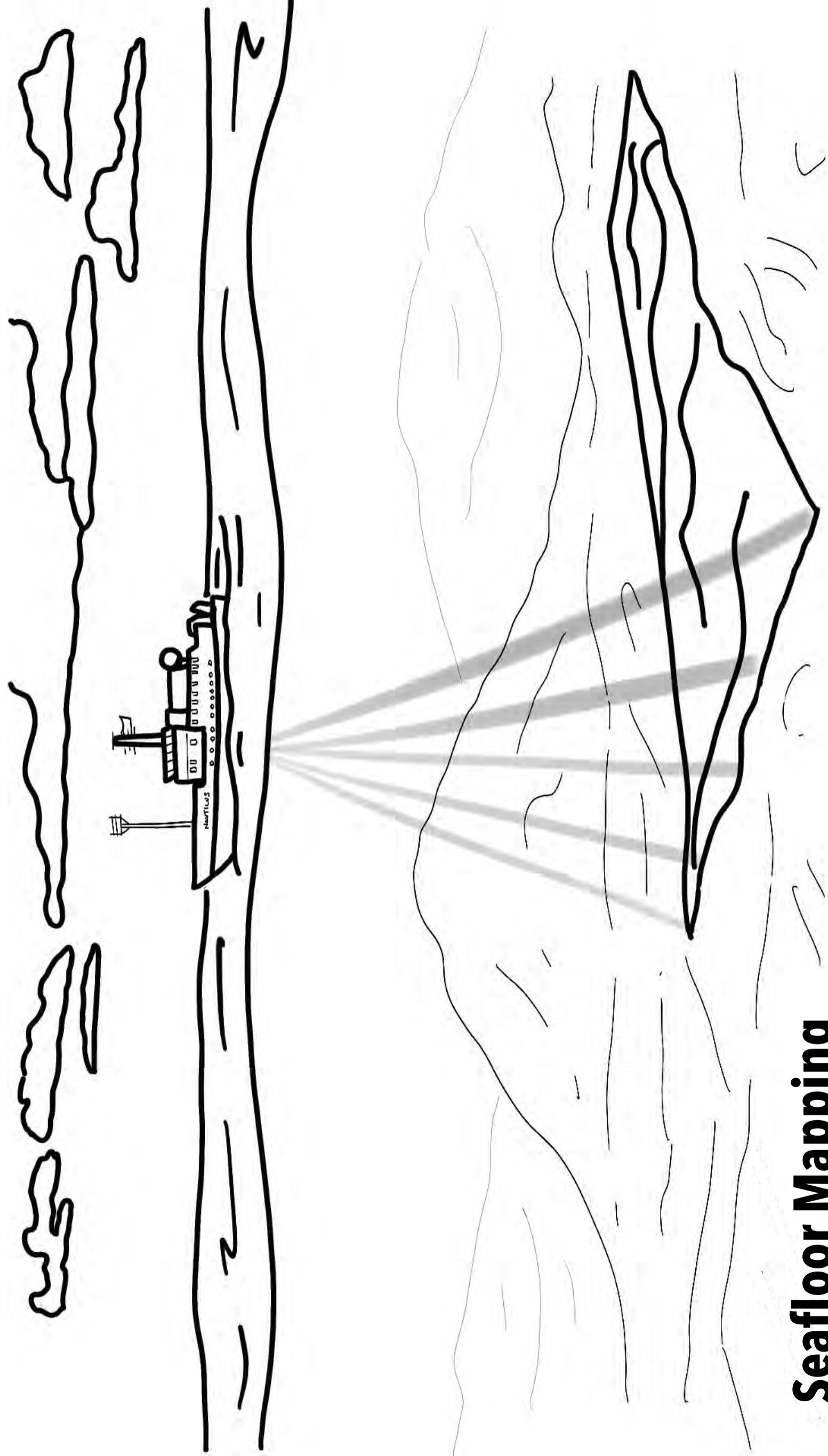

## Seafloor Mapping

When exploring little-known regions of the ocean, we often need to create our own maps to plan operations. Mounted on the hull of E/V *Nautilus*, the multibeam sonar emits pulses of sound to collect data our team uses to determine the shape of the seafloor.

Learn more about our exploration technology at [nautiluslive.org/science-tech](https://nautiluslive.org/science-tech).

Share your art! #WorldOceanArt



NAUTILUSLIVE.ORG  
OCEAN EXPLORATION TRUST